



Congratulations on the purchase of your new DMI Sports Table hockey table. Our products are designed and manufactured to give you years of game playing enjoyment.

*KEEP BOX AND PACKING MATERIAL UNTIL TABLE HAS BEEN COMPLETELY ASSEMBLED.*

*ALL DAMAGE MUST BE REPORTED TO DMI WITHIN TEN DAYS OF RECEIPT.*

*If you have any problems with your new product,*

**PLEASE DO NOT RETURN IT TO THE STORE.**

Please contact us:

**1.800.399.4402**

**FAX: 215.283.9573**

Please have your model number when inquiring about parts.

Or write to:

DMI Sports

Customer Service

375 Commerce Drive

Fort Washington PA, 19034

Please visit our web site at:

**[www.dmisports.com](http://www.dmisports.com)**

When contacting DMI Sports, please provide your model number and item number (if applicable) if requesting a replacement part. Item numbers can be found inside this owners manual.

Your Model Number **HT115**

**Your model number is also located on the original carton. These instructions are also available online at: [www.dmisports.com](http://www.dmisports.com).**

# IMPORTANT!

**Please Keep Your Instructions!** (You will need your Model number should you need to contact us.) Before attempting assembly, please read through this instruction book to familiarize yourself with all the parts and assembly steps. We recommend that two adults assemble this table. Please refer to the Parts Identifier on the following page and be sure that all parts have been included. Although extremely rare, occasionally a part may be missing. If you are missing a part, or if you have any questions, please call our customer service department at 1.800.399.4402 Mon-Fri between the hours of 9:00am and 5:00pm E.S.T; or you can reach us at: [www.dmisports.com](http://www.dmisports.com).

Do not return the game to the store. Please contact us first at: 1.800.399.4402 or on our website at: [www.dmisports.com](http://www.dmisports.com).

## TWO ADULTS ARE REQUIRED TO ASSEMBLE THIS HOCKEY TABLE







**TOOLS REQUIRED FOR ASSEMBLY:**



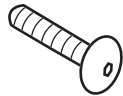

- Phillips Head Screw driver-**Included**
- Level recommended- **Not Included**
- Allen Wrench - **Included**

**PARTS IDENTIFIER**



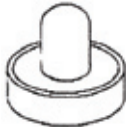



**HARDWARE PARTS**

H1	Qty. 12	H2	Qty. 12	H3	Qty. 8	H4	Qty. 4
							
<b>Leg Bolt</b> RPHT115-LGBOLT		<b>Washer, Leg</b> RPHT115-WASH		<b>Goal Screw</b> RPHT115-GOALSCR		<b>Extreme Blind Bolt</b> RPHT115-BLNDBLT	

**ACCESSORY PARTS**

A1	Qty. 2	A2	Qty. 2	A3	Qty. 2	A4	Qty. 1
							
<b>Small Pusher</b> RPHT-SMPUSHER		<b>Small Felt Pad</b> RPHT-SMFELT		<b>Small Puck</b> RPHT-SMPUCK		<b>Allen Wrench</b> RPHT-AWRENCH	

**ASSEMBLY PARTS**

P1	Qty. 1	P2	Qty. 4	P3	Qty. 2	P4	Qty. 2
							
<b>Main Frame</b> RPHT115-FRAME		<b>Leg</b> RPHT115-LEG		<b>Leg Brace</b> RPHT115-BRACE		<b>Blind Spports</b> RPHT115-BLNDSPPT	
P5	Qty. 1	P6	Qty. 2				
							
<b>Extreme Blind</b> RPHT115-BLIND		<b>Score/Goal Box</b> RPHT115-GOAL					

## ASSEMBLY

**NOTE:** Please leave Main Frame (P1) face down in the carton that it ships in until the legs are attached. All images are shown UP-SIDE-DOWN until the table is turned up on its legs. Unpack all contents and lay out on the floor. Verify all parts listed on parts list are present.

### STEP 1.

Attach two Legs (P2) to the Main Frame (P1) as shown in Figure 1.1. Secure one leg, using Leg Bolt (H1) and Washer (H2), before placing a Leg Brace (P3) between the two legs. Once the support brace is in place, secure the second leg. Repeat this step for the second pair of legs on the other end of the table.

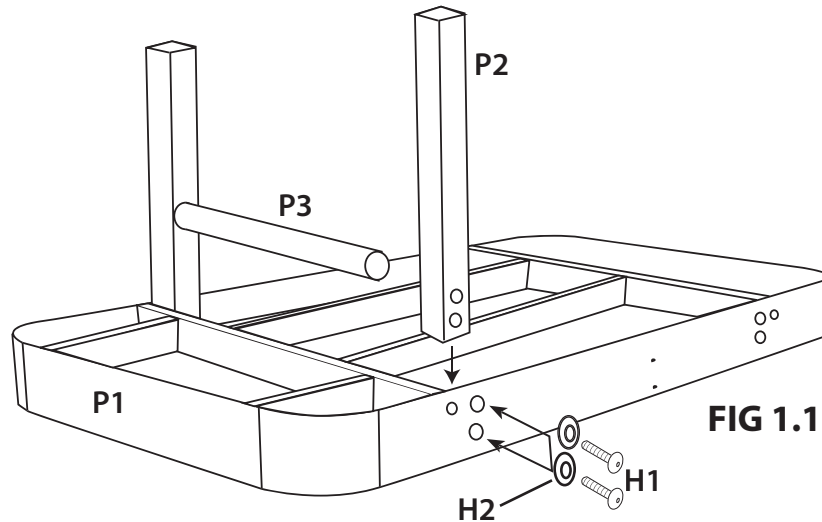

### STEP 2.

Once all of the legs are in place and tightened, with two adults, carefully turn the table over onto its legs. You will now attach the Blind Supports (P4) on each side of the table using Bolt (H4). Be sure to attach the blind supports with the tracks facing the table. With the supports in place, slide the Blind (P5) down between the two supports and set it to your desired height.

### STEP 3.

Now attach the Goal Box/Slide Scorer (P6) to each end of the table using Screw (H3). Please note, there are four pre-drilled holes on each end of the table. Carefully align the goal boxes with these pre-drilled holes before securing the goals in place.

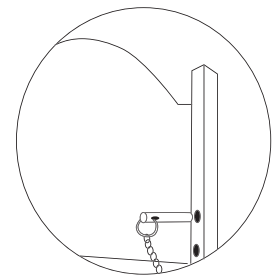
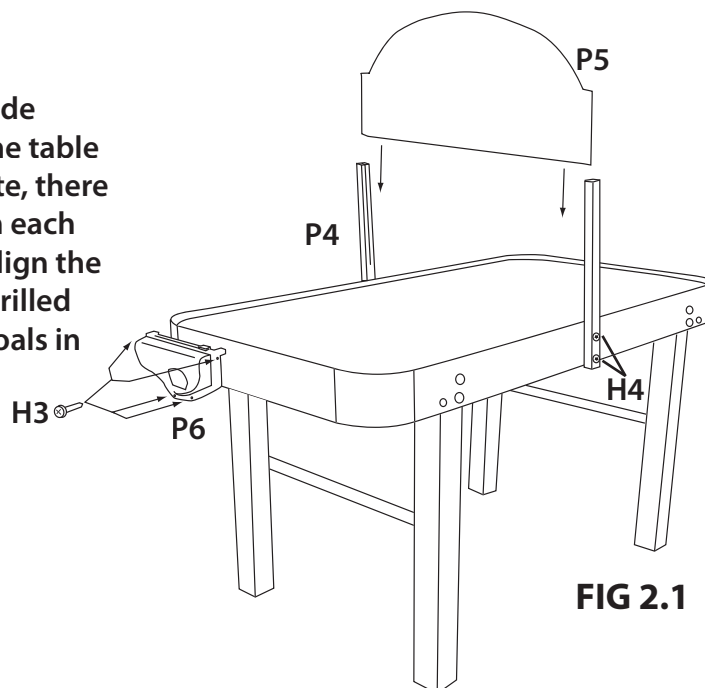

**NOTE:** The Extreme Hockey Blind is adjustable to create a more challenging game or removable for traditional game play. To adjust the height, or remove the blind, simply remove the pin from the hole in the support and slide the blind up or down.

