



Congratulations on the purchase of your new DMI Sports Table hockey table. Our products are designed and manufactured to give you years of game playing enjoyment.

*KEEP BOX AND PACKING MATERIAL UNTIL TABLE HAS BEEN COMPLETELY ASSEMBLED.*

*ALL DAMAGE MUST BE REPORTED TO DMI WITHIN TEN DAYS OF RECEIPT.*

*If you have any problems with your new product,*

**PLEASE DO NOT RETURN IT TO THE STORE.**

Please contact us:

**1.800.399.4402**

**FAX: 215.283.9573**

Please have your model number when inquiring about parts.

Or write to:

DMI Sports

Customer Service

375 Commerce Drive

Fort Washington PA, 19034

Please visit our web site at:

**[www.dmisports.com](http://www.dmisports.com)**

When contacting DMI Sports, please provide your model number and item number (if applicable) if requesting a replacement part. Item numbers can be found inside this owners manual.

Your Model Number HT285

**Your model number is also located on the original carton. These instructions are also available online at: [www.dmisports.com](http://www.dmisports.com).**

## **IMPORTANT!**

**Please Keep Your Instructions!** (You will need your Model number should you need to contact us.) Before attempting assembly, please read through this instruction book to familiarize yourself with all the parts and assembly steps. We recommend that two adults assemble this table. Please refer to the Parts Identifier on the following page and be sure that all parts have been included. Although extremely rare, occasionally a part may be missing. If you are missing a part, or if you have any questions, please call our customer service department at 1.800.399.4402 Mon-Fri between the hours of 9:00am and 5:00pm E.S.T; or you can reach us at: [www.dmisports.com](http://www.dmisports.com).

Do not return the game to the store. Please contact us first at: 1.800.399.4402 or on our website at: [www.dmisports.com](http://www.dmisports.com).

## **TWO ADULTS ARE REQUIRED TO ASSEMBLE THIS HOCKEY TABLE**











**TOOLS REQUIRED FOR ASSEMBLY:**





- Allen Wrench- Included
- Wrench - Included
- Level recommended Not Included

**PARTS IDENTIFIER**

**HARDWARE PARTS**







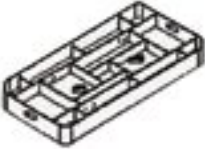

H1	Qty. 12	H2	Qty. 24	H3	Qty. 12	H4	Qty. 8
							
3/8" Bolt RPHT280-3/8BOLT		3/8" Washer RPHT280-3/8WASH		3/8" Hex Nut RPHT280-3/8NUT		3/4" Screw RPHT280-3/4	
H5	Qty. 8	H6	Qty. 16	H7	Qty. 24	H8	Qty. 16
							
F4 Screw RPHT280-F4SCREW		1/4" Allen Bolt RPHT280-1/4ABL		1/4" Washer RPHT280-1/4WASH		1/4" Threaded Insert Nut RPHT280-1/4NUT	

**ACCESSORY PARTS**

A1	Qty. 4	A2	Qty. 4	A3	Qty. 4	A4	Qty. 1
							
Pusher RPHT-PUSH		Felt Pad RPHT-FELT		Goal Flex™ Puck RPHT-PUCK		Wrench, Multi RPHT-MWRENCH	
A5	Qty. 1						
							
1/4" Allen Tool RPHT-1/4TOOL							

## PARTS IDENTIFIER

### ASSEMBLY PARTS

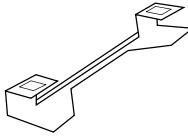
P1	Qty. 1	P2	Qty. 2	P3	Qty. 2	P4	Qty. 2
 <b>Main Frame</b> RPHT285-FRAME		 <b>Panel, Leg</b> RPHT280-PANEL		 <b>Console</b> RPHT285-CONSOLE		 <b>Right Leg</b> RPHT280-RLEG	
P5	Qty. 2	P6	Qty. 2	P7	Qty. 2	P8	Qty. 4
 <b>Left Leg</b> RPHT280-LLEG		 <b>Stretcher, Upper</b> RPHT280-UPSTRCH		 <b>Stretcher, Lower</b> RPHT280-LOWSTRC		 <b>Leg Base(Foot)</b> RPHT280-FOOT	
P9	Qty. 4	P10	Qty. 1				
 <b>Leg Leveler</b> RPHT280-LEV		 <b>Console Bracket</b> RPHT-BRACKET					

## ASSEMBLY

**NOTE:** Please leave Main Frame (P1) face down in the carton that it ships in until the legs are attached. All images are shown up-side-down until the table is turned up on its legs.

### STEP 1.

To assemble each arched leg, secure Left Leg (P5) to the Right Leg (P4) with Upper Stretcher (P6) and Lower Stretcher (P7) by screwing 1/4" Bolts (H6) and 1/4" Washer (H7) into Threaded Insert Nuts (H8) as shown below. Note: (P7) has a slight curve along the outer edge and is intended to be the bottom support. Do not tighten until you have inserted the curved Leg Panel (P2). Once the Leg Panel has been positioned in place, tighten bolts and washers firmly. (DO NOT OVER TIGHTEN)

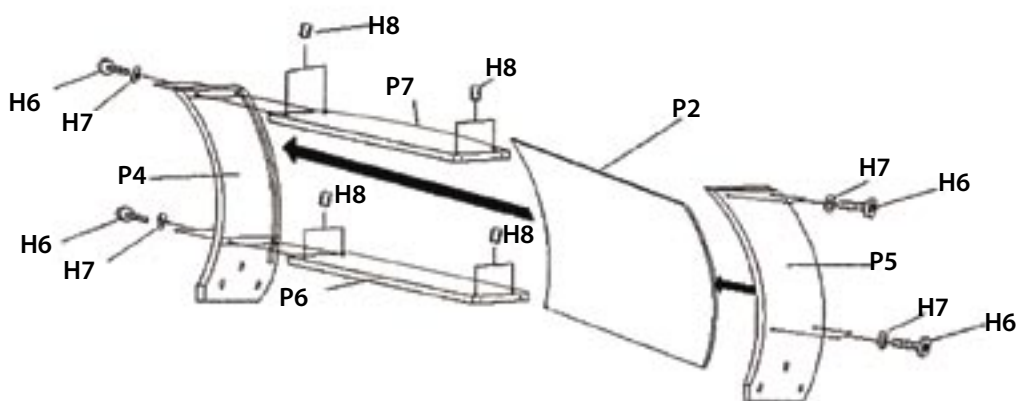

**FIG 1.1**

### STEP 2.

Secure each Leg Base (P8) with F4 Screws (H5). Be sure to secure these Leg bases evenly on both sides of arched leg structure for best appearance.

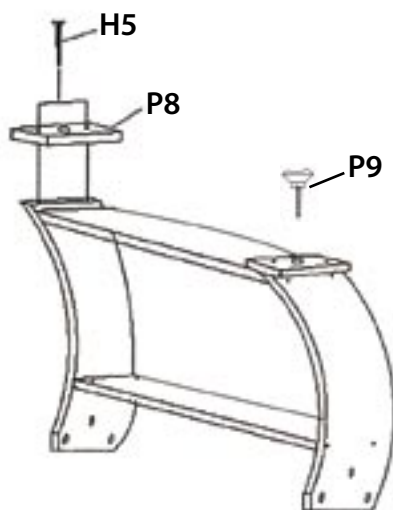

### IMPORTANT

When attaching Leg Base, make sure Leg Leveler (P9) will thread completely through Leg base and slot in leg.

**FIG 2.1**

## ASSEMBLY

### STEP 3.

Set each assembled leg structure between Main Frame (P1) support beams as indicated in Fig. 3.1 and secure tightly with Bolt (H1), Washer (H2) and Hex Nut (H3). **DO NOT STAND ON TABLE STRUCTURE TO POSITION LEG ASSEMBLY.** Screw in Leg Levelers (P9).

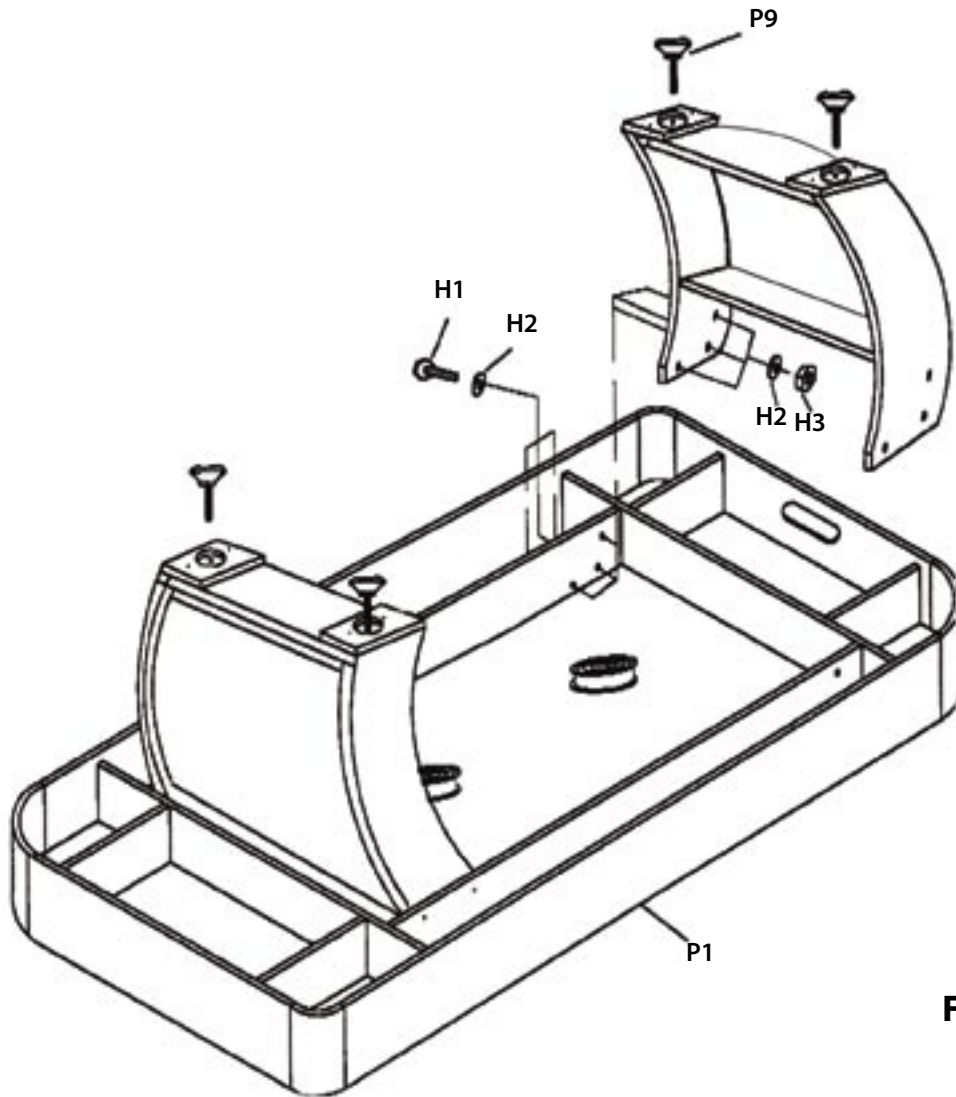

**FIG 3.1**

**STEP 4.**

With the assistance of at least one adult, gradually lift and turn your new Hockey Table over.

**Attaching Goal Flex Components:**

Secure Console Bracket (P10) to the side rail of your table using Screws (H4). Note: Bracket indicates direction of play surface.

Feed console power wire, "Home" and "Visitor" goal sensor wires through partially covered rail hole and attach to underside of Console (P3) unit as indicated. Attach the Console (P3) to the console bracket by placing the console on top of the bracket and gently sliding it back until it snaps into place. Plug in your console.

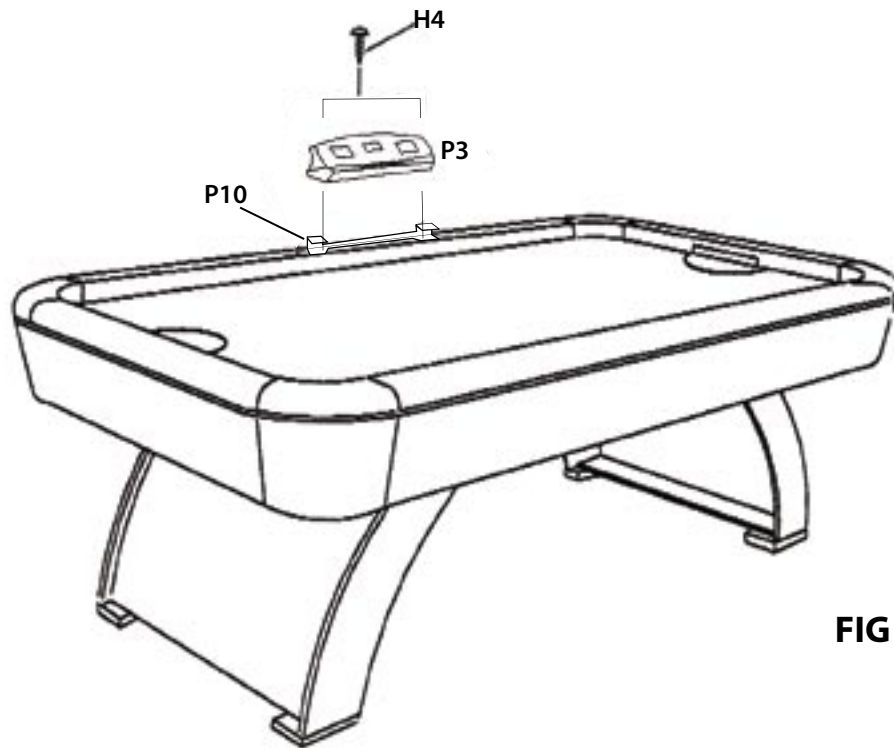

**FIG 4.1**

**STEP 5.**

Apply Felt Pads (A2) to the bottom of your Pushers (A1). Congratulations, you're ready to play!

