



Congratulations on the purchase of your new DMI Sports Table hockey table. Our products are designed and manufactured to give you years of game playing enjoyment.

KEEP BOX AND PACKING MATERIAL UNTIL TABLE HAS BEEN COMPLETELY ASSEMBLED.

ALL DAMAGE MUST BE REPORTED TO DMI WITHIN TEN DAYS OF RECEIPT.

If you have any problems with your new product,

PLEASE DO NOT RETURN IT TO THE STORE.

Please contact us:

1.800.399.4402

FAX: 215.283.9573

Please have your model number when inquiring about parts.

Or write to:

DMI Sports

Customer Service

375 Commerce Drive

Fort Washington PA, 19034

Please visit our web site at:

www.dmisports.com

When contacting DMI Sports, please provide your model number and item number (if applicable) if requesting a replacement part. Item numbers can be found inside this owners manual.

Your Model Number HT350

Your model number is also located on the original carton. These instructions are also available online at: www.dmisports.com.

IMPORTANT!

Please Keep Your Instructions! (You will need your Model number should you need to contact us.) Before attempting assembly, please read through this instruction book to familiarize yourself with all the parts and assembly steps. We recommend that two adults assemble this table. Please refer to the Parts Identifier on the following page and be sure that all parts have been included. Although extremely rare, occasionally a part may be missing. If you are missing a part, or if you have any questions, please call our customer service department at 1.800.399.4402 Mon-Fri between the hours of 9:00am and 5:00pm E.S.T; or you can reach us at: www.dmisports.com.

Do not return the game to the store. Please contact us first at: 1.800.399.4402 or on our website at: www.dmisports.com.

TWO ADULTS ARE REQUIRED TO ASSEMBLE THIS HOCKEY TABLE











TOOLS REQUIRED FOR ASSEMBLY:





- Allen Wrench- Included
- Wrench - Included
- Level recommended Not Included

PARTS IDENTIFIER

HARDWARE PARTS









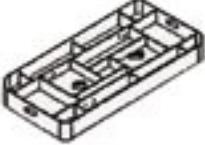

H1	Qty. 12	H2	Qty. 24	H3	Qty. 12	H4	Qty. 8
 3/8" Bolt RPHT-3/8BOLT		 3/8" Washer RPHT-3/8WASH		 3/8" Hex Nut RPHT-3/8NUT		 Bolt 1/4" x 1-1/8" RPHT-1/4BOLT	
H5	Qty. 8	H6	Qty. 16	H7	Qty. 24	H8	Qty. 16
 F4 Screw RPHT-F4SCREW		 1/4" Allen Bolt RPHT-1/4ABL		 1/4" Washer RPHT-1/4WASH		 1/4" Threaded Insert Nut RPHT-1/4NUT	
H9	Qty. 2						
 Screw RPHT510-SCREW							

ACCESSORY PARTS

A1	Qty. 4	A2	Qty. 4	A3	Qty. 4	A4	Qty. 1
 Pusher RPHT-PUSH		 Felt Pad RPHT-FELT		 Goal Flex™ Puck RPHT-GFPUCK		 Wrench, Multi RPHT-MWRENCH	
A5	Qty. 1						
 1/4" Allen Tool RPHT-1/4TOOL							

PARTS IDENTIFIER

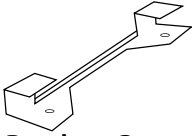
ASSEMBLY PARTS

P1	Qty. 1	P2	Qty. 2	P3	Qty. 2	P4	Qty. 2
 Main Frame RPHT350-FRAME		 Panel, Leg RPHT350-PANEL		 Support, Leg Cross RPHT350-LEGSUPP		 Right Leg RPHT350-RLEG	
P5	Qty. 2	P6	Qty. 2	P7	Qty. 2	P8	Qty. 4
 Left Leg RPHT350-LLEG		 Stretcher, Upper RPHT350-UPSTRCH		 Stretcher, Lower RPHT350-LOWSTRC		 Leg Base(Foot) RPHT350-FOOT	
P9	Qty. 4	P10	Qty. 1	P11	Qty. 1		
 Leg Leveler RPHT350-LEV		 Bracket, Console RPHT-BRACK		 Console RPHT350-CONSOLE			

ASSEMBLY

NOTE: Please leave Main Frame (P1) face down in the carton that it ships in until the legs are attached. All images are shown up-side-down until the table is turn up on its legs.

STEP 1.

To assemble each arched leg, secure Left Leg (P5) to the Right Leg (P4) with Upper Stretcher (P6) and Lower Stretcher (P7) by screwing 1/4" Bolts (H6) and 1/4" Washer (H7) into Threaded Insert Nuts (H8) as shown below. Note: (P7) has a slight curve along the outer edge and is intended to be the bottom support. Do not tighten until you have inserted the curved Leg Panel (P2). Once the Leg Panel has been positioned in place, tighten bolts and washers firmly.

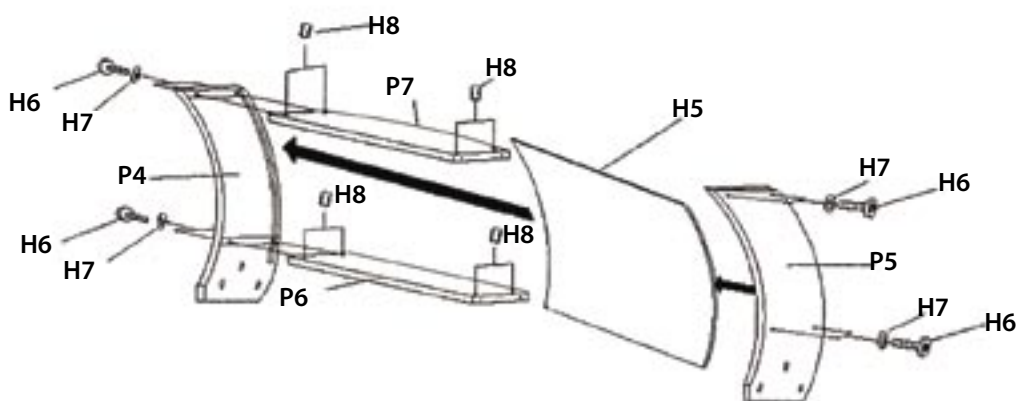
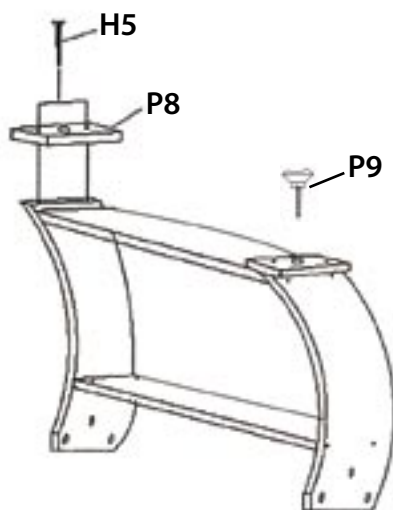

FIG 1.1

STEP 2.

Secure each Leg Base (P8) with F4 Screws (H5). Be sure to secure these Leg bases evenly on both sides of arched leg structure for best appearance.



IMPORTANT

When attaching Leg Base, make sure Leg Leveler (P9) will thread completely through Leg base and slot in leg.

FIG 2.1

ASSEMBLY

STEP 3.

Set each assembled leg structure between Main Frame (P1) support beams as indicated in the diagram and secure tightly with Bolt (H1) and Washer (H2). **DO NOT STAND ON TABLE STRUCTURE TO POSITION LEG ASSEMBLY.** Screw in Leg Levelers (P9).

STEP 3.a

Position each Support Leg Cross (P3) between legs. Secure Bolts (H4) and Washers (H7) and tighten firmly.

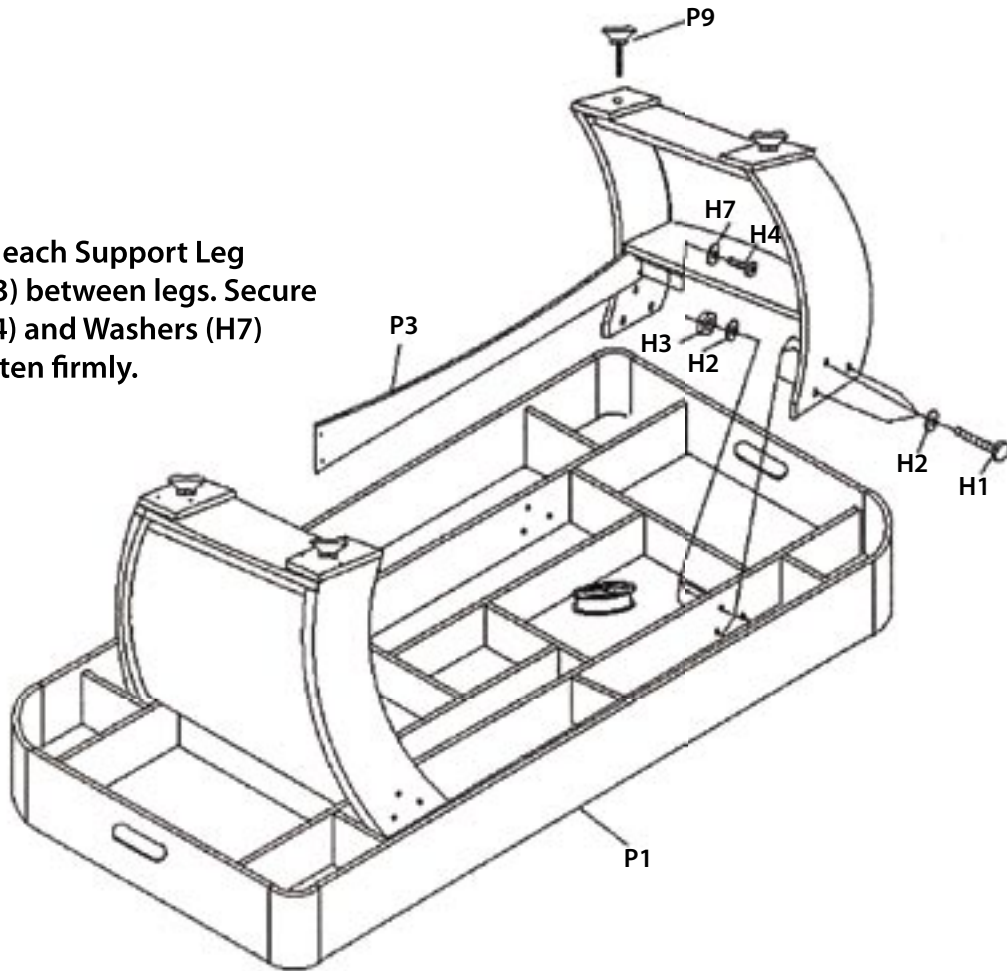

FIG 3.1

STEP 4.

With the assistance of at least one adult, gradually lift and turn your new Hockey Table over. Plug in the blow motor.

Attaching Goal Flex™ Components: Secure Console Bracket (P10) to the side rail with two Screws (H9). Note: Bracket indicates direction of play surface. Feed console power wire, "Home" and "Visitor" goal sensor wires through partially covered rail hole and attach to underside of Console (P11) unit as indicated. Gently slide wired console unit on to secured bracket until it locks into place.

Refer to Goal Flex™ Operating Instructions manual for operating instructions on Goal flex™.

Goal Flex™ Operating Instructions can also be found on-line at: www.dmisports.com/instructions

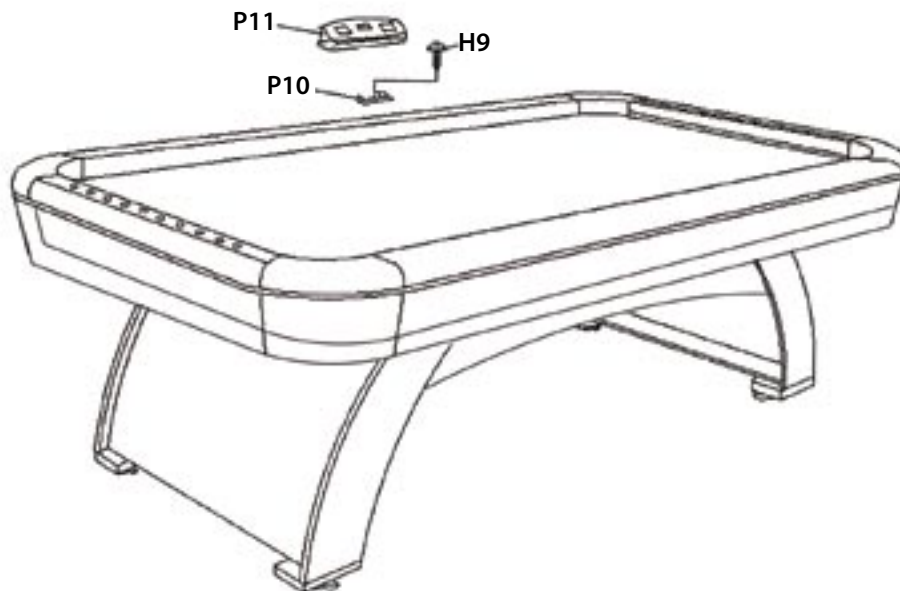

STEP 5.

Apply Felt Pads (A2) to the bottom of your Pushers (A1). Congratulations, you're ready to play!

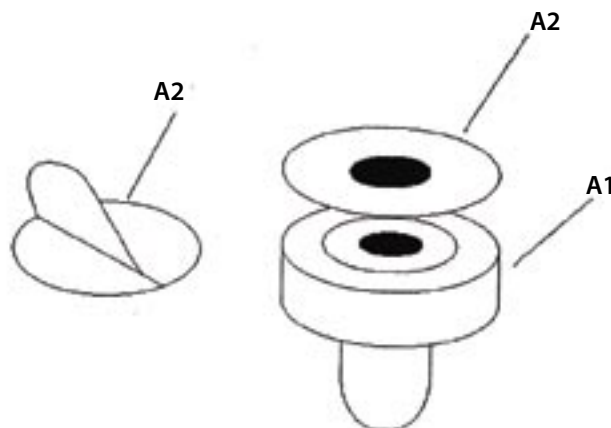

PARTS RE-ORDER FORM**HT350 Table Hockey table**Send this form along with your
check or money order payable to:**DMI SPORTS**375 Commerce Drive
Fort Washington, PA 19034
www.dmisports.com

DATE: _____

NAME: _____

ADDRESS: _____ PHONE: _____

CITY: _____ STATE: _____ ZIP CODE: _____

REF	QTY	PART#	DESCRIPTION	UNIT PRICE	TOTAL AMOUNT
H1		RPHT-3/8"BOLT	3/8" Bolt (ea.)	.50	
H2		RPHT-3/8WASH	3/8" Washer (ea.)	.25	
H3		RPHT-3/8NUT	3/8" Hex Nut (ea.)	.50	
H4		RPHT-1/4BOLT	1/4" x 1-1/8" Bolt (ea.)	.50	
H5		RPHT-F4SCREW	F4 Screw (ea.)	.75	
H6		RPHT-1/4ABLT	1/4" Allen Bolt (ea.)	1.00	
H7		RPHT-1/4WASH	1/4" Washer (ea.)	.25	
H8		RPHT-1/4NUT	1/4" Threaded Insert Nut (ea.)	.50	
H9		RPHT-SCREW	Screw (ea.)	.50	
P2		RPHT350-PANEL	Panel, Leg (ea.)	15.00	
P3		RPHT350-LEGSUPP	Support, Leg Cross (ea.)	18.00	
P4		RPHT350-RLEG	Right Leg (ea.)	20.00	
P5		RPHT350-LLEG	Left leg (ea.)	20.00	
P6		RPHT350-UPSTRCH	Stretcher, Upper (ea.)	15.00	
P7		RPHT350-LOWSTRC	Stretcher, Lower (ea.)	15.00	
P8		RPHT350-FOOT	Leg Base (Foot) (ea.)	7.50	
P9		RPHT350-LEV	Leg Leveler (ea.)	4.00	
P10		RPHT-BRACK	Bracket, Console (ea.)	3.00	
P11		RPHT350-CONSOLE	Console (ea.)	50.00	
A1		RPHT-PUSH	Pusher (ea.)	2.00	
A2		RPHT-FELT	Felt Pad (ea.)	1.00	
A3		RPHT-GFPUCK	Goal Flex™ Puck (ea.)	1.50	
A4		RPHT-MWRENCH	Wrench, Multi (ea.)	2.00	
A5		RPHT-1/4TOOL	1/4" Allen Tool (ea.)	1.00	
		RPHT350-JUNCT	Junction Box (ea.)	16.00	
		RPHT350-MOTOR	Blower Motor (ea.)	49.00	
		RPHT350-GOALRAI	16 LED Goal Rail (ea.)	69.00	

SHIPPING AND HANDLING:**Subtotal:****Up to \$15.00 add \$2.00 for S&H****PA Residents Add 6% State Sales Tax:****Over \$15.00 add \$8.00 for S&H****Shipping and Handling Charges:****Console add \$5.00 for S&H****TOTAL:**