

# Minnesota **FATS**<sup>®</sup>

Congratulations on the purchase of your new Billiard table by DMI Sports. Our products are designed and manufactured to give you years of game playing enjoyment.

*KEEP BOX AND PACKING MATERIAL UNTIL TABLE HAS BEEN COMPLETELY ASSEMBLED.*

*ALL DAMAGE MUST BE REPORTED TO DMI WITHIN TEN DAYS OF RECEIPT.*

*If you have any problems with your new product,*

**PLEASE DO NOT RETURN IT TO THE STORE.**

Please contact us:

**1.800.399.4402**

**FAX: 215.283.9573**

Please have your model number when inquiring about parts.

Or write to:

DMI Sports

Customer Service

375 Commerce Drive

Fort Washington PA, 19034

Please visit our web site at:

**[www.dmisports.com](http://www.dmisports.com)**

When contacting DMI Sports, please provide your model number and item number (if applicable) if requesting a replacement part. Item numbers can be found inside this owners manual.

Your Model Number **MFT800-7.5**

**Your model number is also located on the original carton. These instructions are also available online at: [www.dmisports.com](http://www.dmisports.com).**

## **IMPORTANT!**

**Please Keep Your Instructions!** (You will need your Model number should you need to contact us.) Before attempting assembly, please read through this instruction book to familiarize yourself with all the parts and assembly steps. We recommend that two adults assemble this table. Please refer to the Parts Identifier on the following page and be sure that all parts have been included. Although extremely rare, occasionally a part may be missing. If you are missing a part, or if you have any questions, please call our customer service department at 1.800.399.4402 Mon-Fri between the hours of 9:00am and 5:00pm E.S.T; or you can reach us at: [www.dmisports.com](http://www.dmisports.com).

Do not return the game to the store. Please contact us first at: 1.800.399.4402 or on our website at: [www.dmisports.com](http://www.dmisports.com).

## **TWO ADULTS ARE REQUIRED TO ASSEMBLE THIS POOL TABLE**

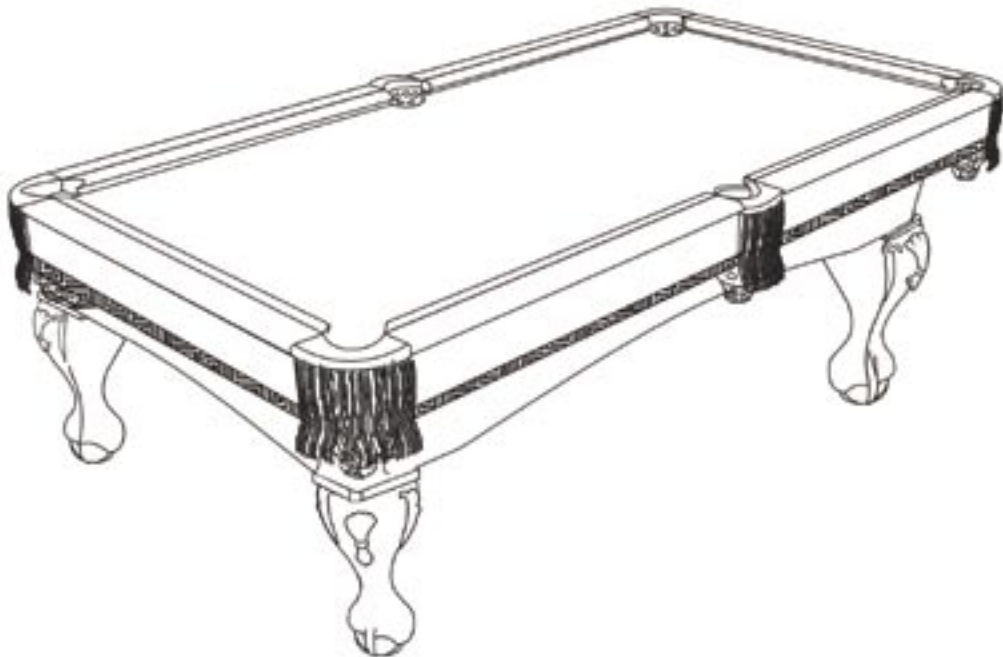





**TOOLS REQUIRED FOR ASSEMBLY:**





- Allen Wrench- Included
- Phillips Head Screw Driver - Included on Allen Wrench
- Level recommended Not Included

**PARTS IDENTIFIER**

**HARDWARE PARTS**





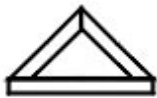



| H1  | Qty. 16 | H2  | Qty. 16 | H3   | Qty. 16 | H4  | Qty. 8 |
|---|---------|---|---------|--|---------|---|--------|
|  |         |  |         |  |         |  |        |
| 8x25mm Bolt<br>RPMFT8007-HKIT   |         | 6x30mm Bolt<br>RPMFT8007-HKIT   |         | 22mm Washer<br>RPMFT8007-HKIT  |         | 3.5x12mm Washer Screw<br>RPMFT8007-HKIT   |        |
| H5  | Qty. 16 |   |         |  |         |   |        |
|  |         |   |         |  |         |   |        |
| 3.5x33mm Screw<br>RPMFT8007-HKIT  |         |   |         |  |         |   |        |

**ACCESSORY PARTS**

| A1  | Qty. 1 | A2  | Qty. 2 | A3   | Qty. 1 | A4  | Qty. 2 |
|---|--------|---|--------|--|--------|---|--------|
|  |        |  |        |  |        |  |        |
| Allen Wrench<br>RPMFT-AWRENCH   |        | Chalk<br>MFA42405   |        | Billiard Balls<br>MFA41655   |        | 2 Piece Billiard Cues<br>MFR40432   |        |
| A5  | Qty. 1 |   |        |  |        |   |        |
|  |        |   |        |  |        |   |        |
| Triangle<br>MFA40993  |        |   |        |  |        |   |        |

## PARTS IDENTIFIER

### ASSEMBLY PARTS

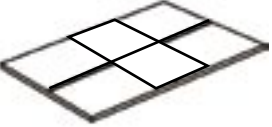
|  |        |   |        |  |        |  |        |
|--|--------|---|--------|--|--------|--|--------|
| P1   | Qty. 1 | P2  | Qty. 4 | P3   | Qty. 4 | P4   | Qty. 2 |
| <br><b>Main Frame</b><br>RPMFT8007-LEG              |        | <br><b>Solid Wood Leg</b><br>RPMFT8007-LEG     |        | <br><b>Leg Support</b><br>RPMFT8007-LSUPP |        | <br><b>End Panel</b><br>RPMFT8007-EPNEL     |        |
| P5   | Qty. 2 | P6  | Qty. 4 | P7   | Qty. 4 | P8   | Qty. 4 |
| <br><b>Side Panel</b><br>RPMFT8007-SPNEL            |        | <br><b>Corner Brace</b><br>RPMFT8007-CBRCE     |        | <br><b>Leg Top</b><br>RPMFT8007-LTOP      |        | <br><b>Corner Bracket</b><br>RPMFT8007-BRCK |        |
| P9   | Qty. 1 | P10   | Qty. 1 |  |        |  |        |
| <br><b>Table Tennis Net Set</b><br>RPMFT8007-TTST |        | <br><b>Conversion Top</b><br>RPMFT8007-CONVT |        |  |        |  |        |

**NOTE:**

- Before assembling this table, place Main Frame (P1) face down on a flat surface until the legs are attached.
- All images are shown up-side-down until the table is turned up on its legs.

## ASSEMBLY

### STEP 1.

Attach Side Aprons (P5) and End Aprons (P4) to the Main Frame (P1) using Corner Brace (P6) at all four corners as shown in FIG. 1.

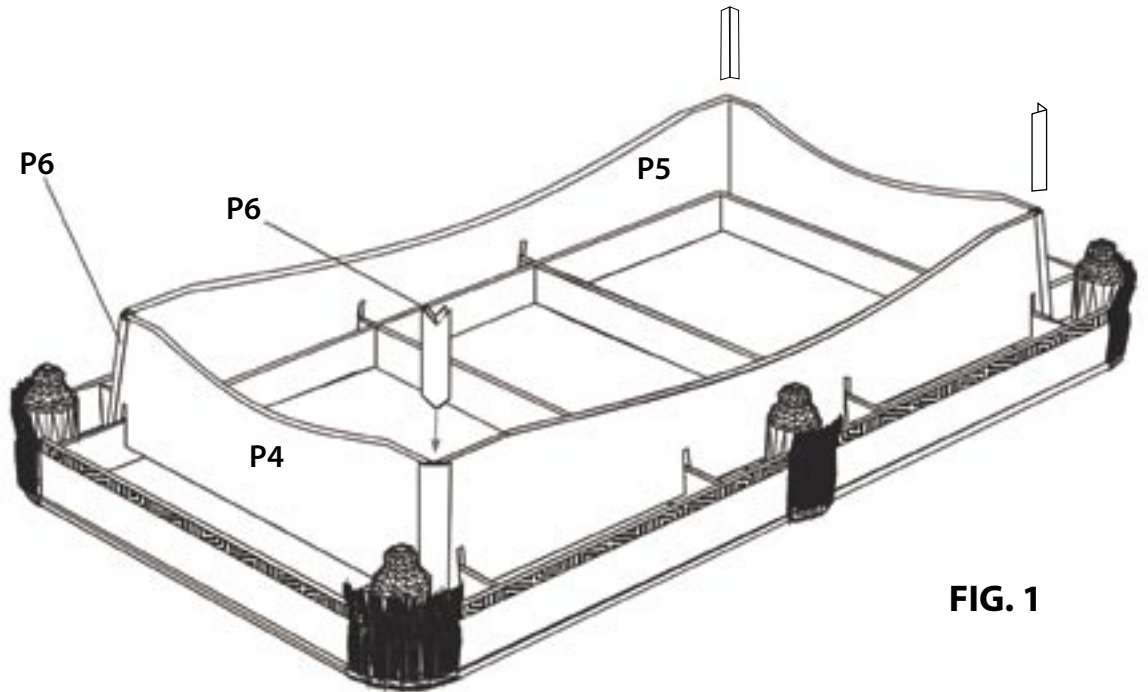

FIG. 1

### STEP 2.

Connect leg assembly by attaching Solid Wood Leg (P2) to Leg Top (P7) using Screw (H7). Now attach Leg Support (P3) using Bolt (H2). Next, attach the leg assemblies to the Main Frame (P1) using Bolt (H1) and Washer (H3) as shown in FIG. 2. Make sure that the groove in the legs are properly aligned with the side and end panels before tightening the (H1) bolts. When the Leg Assemblies are secure, anchor the side aprons to the main frame using Corner Bracket (P8) and Screw (H8).

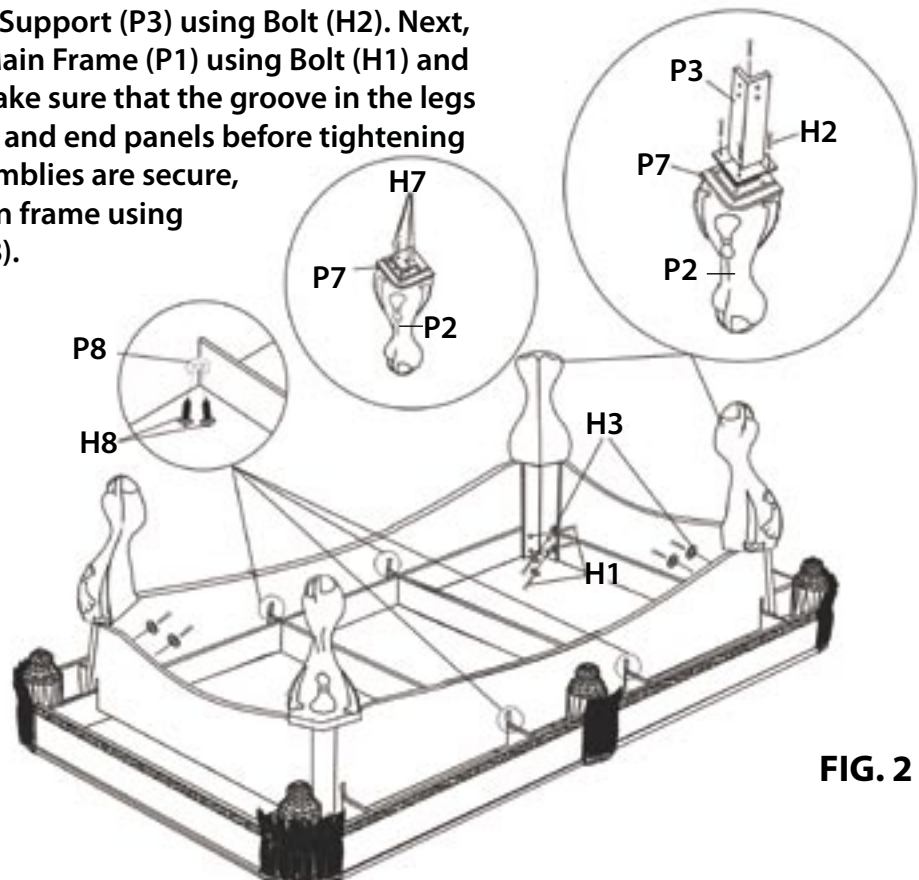
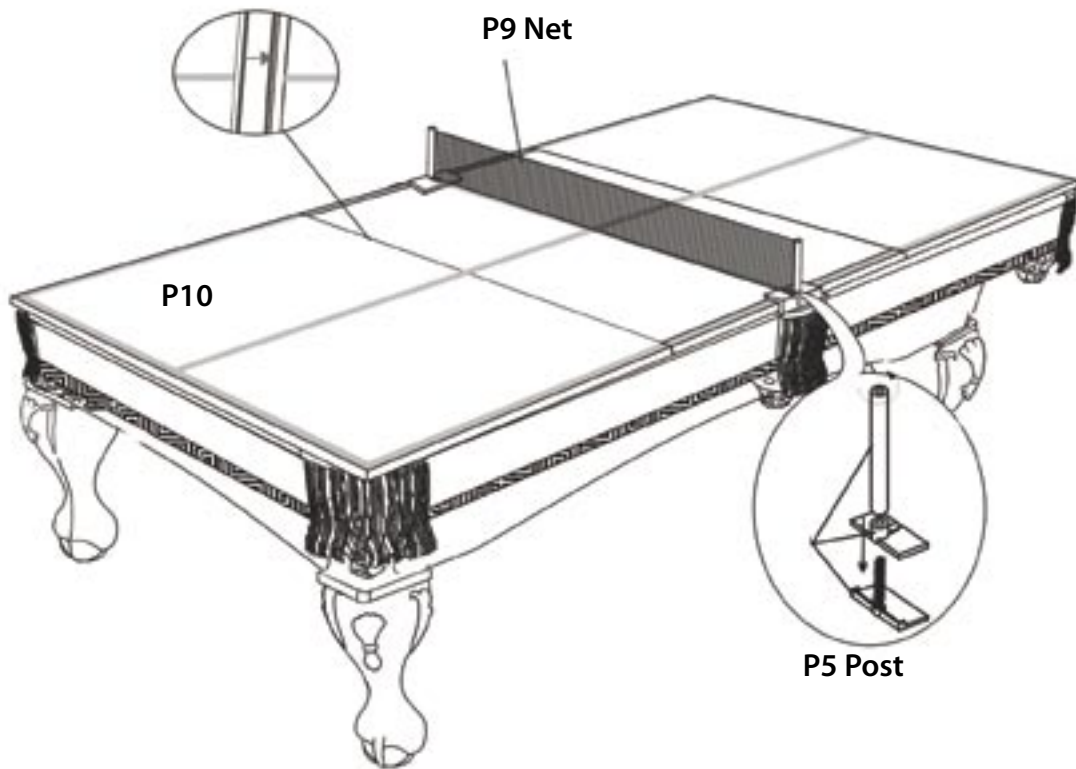
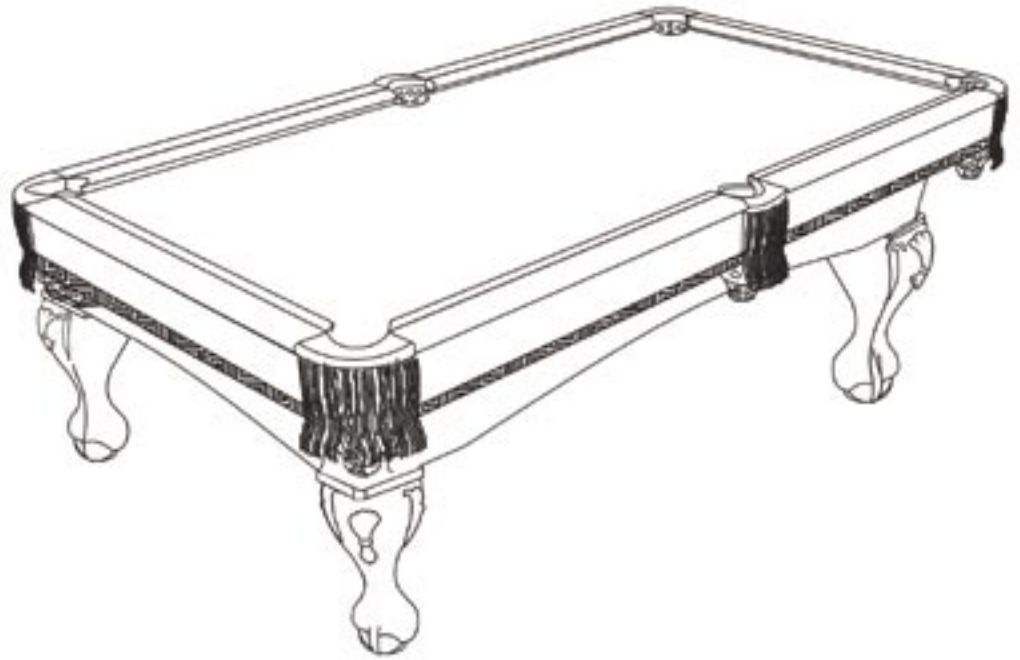
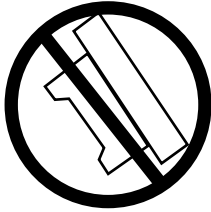

FIG. 2

**IMPORTANT!**

When turning the table over, be sure not to rest the weight of the table on the side of the legs. This could damage the leg.



## INSTRUCTIONS FOR LEVELING A POOL TABLE

- Assemble pool table according to the instructions.
- Any type of level would be sufficient to perform this procedure. However, a two-foot level is recommended.
- Before leveling, make sure level is placed on the playing surface, not the rails.
- Level the ends between the corner pockets: Place the level on the playing surface between the two corner pockets and adjust the height by placing wood shims underneath the leg opposite of which the bubble in the level favors until the bubble rests in the middle of the level.

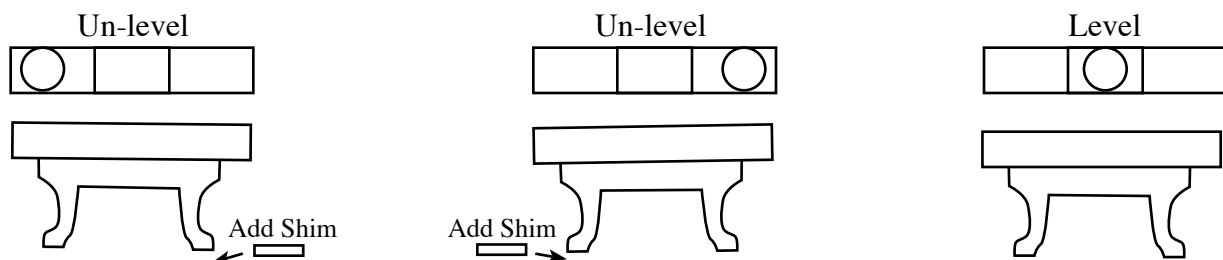

- Repeat the step above to the opposite corner pockets.
- Next, level the length of the table. Place the level next to the side pocket and adjust the height to position the bubble in the middle of the level, using the wood shims beneath the leg opposite of which the bubble in the level favors.
- Repeat the step above to the opposite length of the table.
- Recheck both short ends to ensure bubble is in the middle on the level.
- Depending on the surface the pool table sits, especially deep pile carpeting, the pool table needs to settle for 24 hours. Recheck the level on each side of the table after 24 hours.

